

An Overview on Characteristics of Channel for Wireless Sensor Networks

Mustafa Alper Akkas¹

Abstract:

EM (Electromagnetic) techniques enable efficient wireless communications in different media with different material absorptions. A wide range of novel and important applications in such challenged environments can be realized based on the EM communication mechanism. The main challenge in this area is the realization of efficient and reliable links to establish multi-hop communication and efficiently disseminate data for seamless operation. However, the hostile environments do not allow the direct usage of most, if not all, existing wireless communication and networking solutions, mainly because of the extremely high path loss, small communication range, and high dynamics of the EM waves when penetrating the different medium. In this paper, the propagation based on EM waves in the 315/433 MHz band through a solids: soil, coal, oil sand and liquids: water, salty water and crude oil medium is analyzed in order to explore its applicability. The developed model evaluates the total path loss, the transmission characteristics and bit error rate. The propagation characteristics are investigated through simulation. The theoretical analysis and the simulation results prove the feasibility of wireless communication in the 315/433 MHz band in these environment and highlight several important aspects in this field.

Keywords: electromagnetic absorbance, channel model, path loss, wave propagation, bit error rate, soil, coal, oil sand, water, salty water, crude oil.

1. Introduction

WSNs (Wireless Sensor Networks) are deployed on land, underground, and underwater. A sensor network faces different challenges and constraints according to the environment in the sensor network deployed. There are five types of the wireless sensor network as discussed at [4].

1. Terrestrial Wireless Sensor Network.
2. Wireless Underground Sensor Network.
3. Underwater Wireless Sensor Network.
4. Multi-Media Wireless Sensor Network.
5. Mobile Wireless Sensor Network.

WUSNs (Wireless Underground Sensor Networks) and UWSNs (Underwater Wireless Sensor Networks) are envisioned to operate in quite different underground and liquid environments, including soil, coal, oil sand, water, salty water and crude oil medium. The system architecture of general WUSNs in solid medium: soil [2], coal [3], oil sand [4] and liquids like water [5], salty water [5] and crude oil [4] medium as detailed in [2-5] consists of a large number of wireless sensor nodes.

¹ Department of Computer Engineering, Abant İzzet Baysal University, BOLU 14280, TURKEY, alperakkas@ibu.edu.tr, alperakkas@pau.edu.tr

Hostile underground and underwater environments prevent the direct use of most, if not all, existing wireless communication and networking solutions, due to the extremely high path loss, small communication range, and high dynamics of EM waves when penetrating the solids and liquids medium. In this paper, focused on the system architecture of WUSNs and UWSNs specifically tailored for operation in solids and liquids media. The system architecture of WSNs in different medium is illustrated in Fig. 1. Medium 1 can be soil, coal, oil sand, crude oil or water medium. Medium 2 shows the second medium which is usually air. In a generic WUSNs or UWSNs architecture, there may still be some devices, such as sink nodes, deployed aboveground. Hence, the communication between the underground, underwater sensors and the aboveground sinks should also be considered.

Fig. 1. System architecture of the wireless underwater sensor network

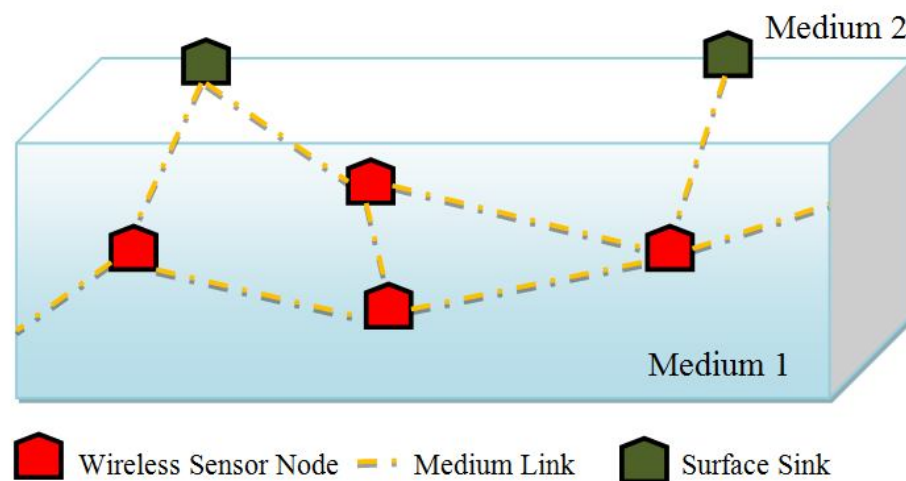

The necessity arises to examine the propagation characteristics of EM waves in different mediums as well and suggest a viable engineering solution that will take into consideration all the requirements. That is why, this work presents a detailed theoretical study of the propagation channel and path loss in different medium. The objective of the paper is to address the unique and important challenges for the realization of wireless sensor networks in challenging environments.

Previous research in the 2.45 GHz band has shown that efficient communication between sensor nodes in underwater and underground environment is possible only for distances of less than 1 m [6, 7]. The channel characteristics of the EM waves are investigated in different mediums in the MHz range which has proven to be better than other bands studied for efficient communication in solid and liquid environment [2, 3]. Wireless nodes with the RF Transceiver TR1000 and CC1000 like MICA, MICA2, MICA2DOT, Cricket, MANTIS nymph motes can also operate in the 315/433 MHz which can increase the efficient communication between sensor nodes comparing with 2.45 GHz. For this reason 315/433 MHz have been used in the analyses. Also, analysis of the communication channel medium at 315/433 MHz band can help users in evaluating results both from underwater and underground environment and simplify deployments by using the same operational method for both cases. On the other hand, decreasing operating frequency below 300 MHz increases the antenna size, which can also hinder practical implementations of WUSNs and UWSNs. Considering that MICA, MICA2, MICA2DOT, Cricket, MANTIS nymph motes operate in the 315/433MHz range, while still preserving small antenna sizes.

WUSNs and UWSNs promise a wide variety of novel applications, including intelligent irrigation, environmental monitoring, infrastructure monitoring, localization, and border patrol. In a lot of these applications the entire application medium consists of water, soil, coal etc. Thus our study aims at providing a detailed theoretical investigation and analytical model for wireless sensor networks used in the case of different media. This paper compared the channel characteristics of the EM waves at 315/433 MHz band in solid medium: soil [2], coal [3], and oil sand [4] and in liquid medium: water [5], salty water [5] and crude oil [4].

From here on the paper is organized as follows. In Sec. II signal propagation in medium which are in solid medium: soil, coal, oil sand and in liquid medium: water, salty water and crude oil are investigated specifically in the 315/433 MHz band. In Sec. III channel characteristics and network performance parameters are described and evaluated in the same mediums and frequency band. Finally, the paper is concluded in Sec. IV.

2. Calculation of Channel Absorption Properties

The unique characteristics of signal propagation in different medium require derivation of the path loss considering the properties of the medium. From the Friis equation [8], it is well known that the received signal strength in free space at a distance d from the transmitter is expressed in the logarithmic form as

$$P_r (dBm) = P_t (dBm) + G_r (dB) + G_t (dB) - PL(d) \quad (1)$$

where P_r is the receiver power, P_t is the transmit power, G_r and G_t are the gains of the receiver and transmitter antennas, and $PL(d)$ is the average path loss at a distance d from the transmitter, given by

$$PL(d) = FSL(d) + PL_{medium} \quad (2)$$

$FSL(d)$ which is showed in equation 2 is free-space path loss that shows the loss in signal strength of an electromagnetic wave that would result from a line-of-sight path through free space, with no obstacles nearby to cause reflection or diffraction.

$$\begin{aligned} FSL(d)(dB) &= 10 \log_{10} \left(\left(\frac{4\pi}{c} df \right)^2 \right) \\ &= 20 \log(d(m)) + 20 \log(f(MHz)) - 27.55. \end{aligned} \quad (3)$$

In equation (3) $FSL(d)$ is showed in dB that for d , f in meters and megahertz, respectively, the constant becomes 27.55, d is the distance between the transmitter and the receiver in meters, f is the operation frequency in MHz, and c is the speed of light in a vacuum, 2.99792458×10^8 m/s. $PL_{medium}(d)$ stands for the additional path loss caused by the propagation in different medium, which is calculated by considering the following differences of EM wave propagation in the medium compared to that in air: (1) the signal velocity, and hence, the wavelength λ , is different and (2) the amplitude of the wave will be attenuated according to the frequency. The additional path loss, $PL_{medium}(d)$, in the medium is, hence, composed of two components which is

$$PL_{medium}(d) = L_\beta + L_\alpha \quad (4)$$

where L_β is the attenuation loss due to the difference of the wavelength of the signal in the medium, λ , compared to the wavelength in free space, λ_0 , and L_α is the transmission loss caused by attenuation with attenuation constant a . Consequently, $L_\beta = 20 \log(\lambda_0/\lambda)$ and $L_\alpha = e^{2ad}$.

Considering that in the medium, the wavelength is $\lambda = 2\pi/\beta$ and in free space $\lambda_0 = c/f$, where β is the phase shifting constant, $c = 2.99792458 \times 10^8$ m/s, and f is the operating frequency, the L_β and L_a can be represented in dB as follows:

$$PL_{medium} = L_\beta \left(\underbrace{20\log\left(\frac{\lambda_0 = c/f}{\lambda = 2\pi/\beta}\right)}_{L_\beta = 154 - 20\log(f) + 20\log(\beta)} (dB) \right) + L_a (8.69\alpha d (dB)). \tag{5}$$

Given that the path loss in free space (3), the path loss, PL_{medium} (5), of an EM wave in the medium is as follows:

$$PL(d) = 6.4 + 20\log(d) + 20\log(\beta) + 8.69\alpha d \tag{6}$$

where the distance, d , is given in meters, the attenuation constant, a , is in 1/m and the phase shifting constant, β , is in radian/m. Note that the path loss, PL_{medium} in (5) depends on the attenuation constant, a , and the phase shifting constant, β . The values of these parameters depend on the dielectric properties of the medium.

The values of a and β depend on the dielectric properties of the medium which is given as $\gamma = a + j\beta$

$$\alpha = 2\pi f \sqrt{\frac{\mu \epsilon'}{2} \left[1 + \left(\frac{\epsilon''}{\epsilon'}\right)^2 - 1 \right]}, \beta = 2\pi f \sqrt{\frac{\mu \epsilon'}{2} \left[1 + \left(\frac{\epsilon''}{\epsilon'}\right)^2 + 1 \right]} \tag{7}$$

where f is the operating frequency, μ is the magnetic permeability. ϵ' and ϵ'' are the real and imaginary parts of the relative dielectric constant of the medium values are taken from [9, 10] for water, [11] for salty water, [12] for oil, [13] for oil sand, [14] for coal (F-5 type coal values are used in this paper) and [2] for soil.

Finally, for deep environment the value of the path loss can be calculated using Equation 6. The reason for this is that in real deep environment the reflection arising at the medium boundaries with air and medium are small enough to be neglected. So, when considering the communication between two nodes in deep environment a single-path model is adopted.

Fig. 2. Path loss for deep environment for 315/43 MHz a) for solids b) for liquids

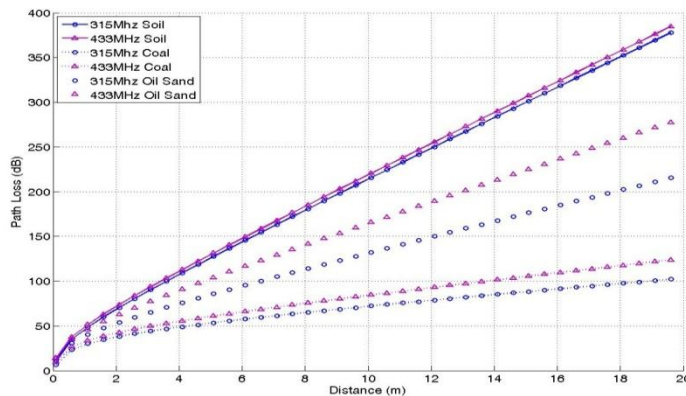

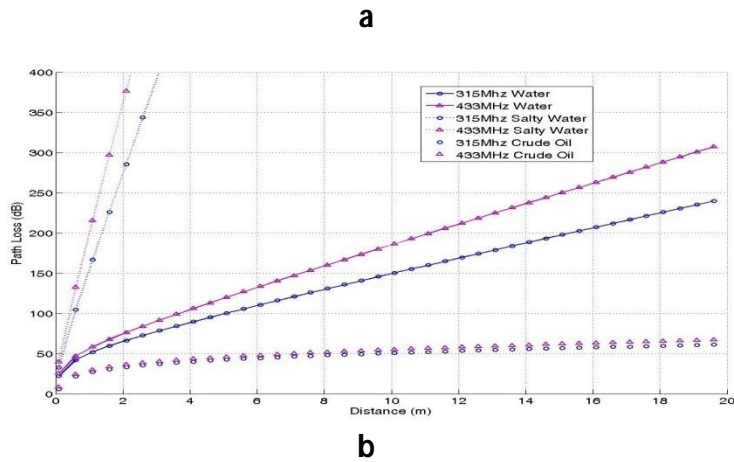

b

Fig. 2 gives the values of path loss for deep environment for 315/43 MHz. Examining the figure in detail, it can be seen that, the path loss increases with increased frequency thus the communication distance is reduced. Suppose, system loss of 100 dB is assumed, then from the graph it can be seen that the communication range for 315 MHz will be up to in solids: 4 meters in soil, 6 meters in oil sand and 18 meters in coal (The coal used in this paper is F-5 type of oil the other types of coal channel properties can be find at paper [3]), in liquids: 0.5 meters in salty water, 5 meters in water, and more than 20 meters in crude oil. On the other hand, the effect of frequency on the communication distance can be examined, for example in water by assuming the reference value of 100 dB system loss and compare the distance at 433 MHz, which is 4 m, to the distance at 315 MHz which is more than 5 m.

In [2,15-17] it has been proven that BPSK (Bipolar Phase Shift Keying) modulation provides the largest range in soil environment. Consequently, in this analysis, BPSK modulation is considered which the BER (Bit Error Rate) can be calculated as: $BER = 0.5 \operatorname{erfc}(\sqrt{\text{SNR}})$, where erfc is the error function and SNR is the signal to noise ratio. In this paper communication channel modelled single-path channel model and two-path channel model in the underground channel such that the envelope of the signal is modelled as an independent Rayleigh distributed random variable, $X_i, i \in \{1,2\}$ [2, 5]. Consequently, for the single-path model, the received energy per bit per noise power spectral density is given by $r = X^2 E_b / N_0$ ($E_b / N_0 = \text{SNR}$), which has a distribution as $f(r) = 1/r_0 \exp(-r/r_0)$, where $r_0 = E[X^2] E_b / N_0$ can be directly found from the signal-to-noise ratio (SNR) of the channel.

Fig. 3. BER for deep environment for 315/433 MHz a) for solids b) for liquids

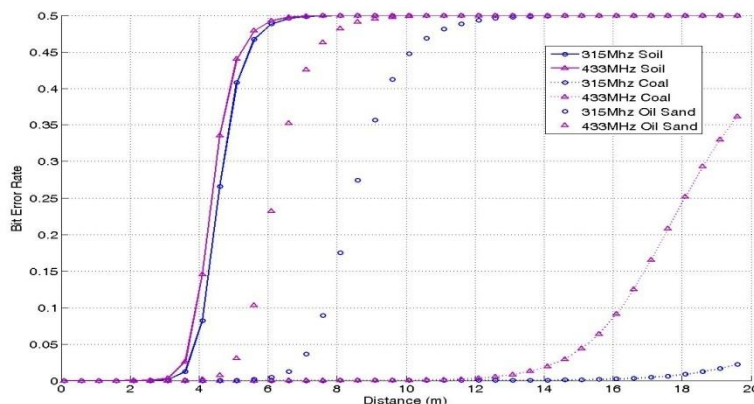

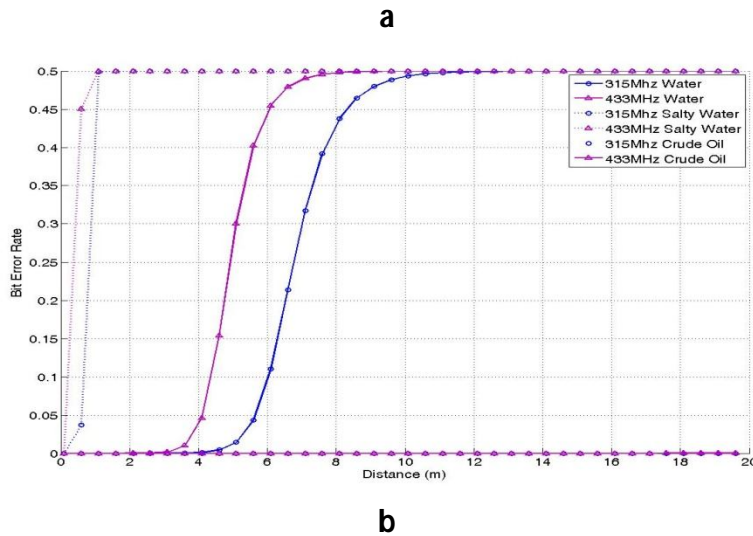

Upon examining Fig. 3, it can be seen that the BER is inverse proportional to the frequency. For a distance of 6 m at 315 MHz the BER value is only 0.1, while at 433 MHz for the same distance the value is increased to 0.45 in water. For a distance of 6 m at 315 MHz the BER value is only 0, while at 433 MHz for the same distance the value is increased to 0.25 in oil sand. BER rate also changes according to distance in the same medium according to the frequency. Fig. 3 also confirms that, given a P_t of 10 dBm, and P_n -100 dBm, for the generally accepted 315 MHz the communication range of the sensors will be in solids: 4 meters in soil, 6 meters in oil sand and 18 meters in coal, in liquids: 0.5 meters in salty water, 6 meters in water, and more than 20 meters in crude oil as seen in Fig. 2. It should also be pointed out that with the reduction in frequency the communication is quickly increased.

Fig. 4. BER for deep environment with transmission power 10-30 dBm at 315 MHz a) for solids b) for liquids

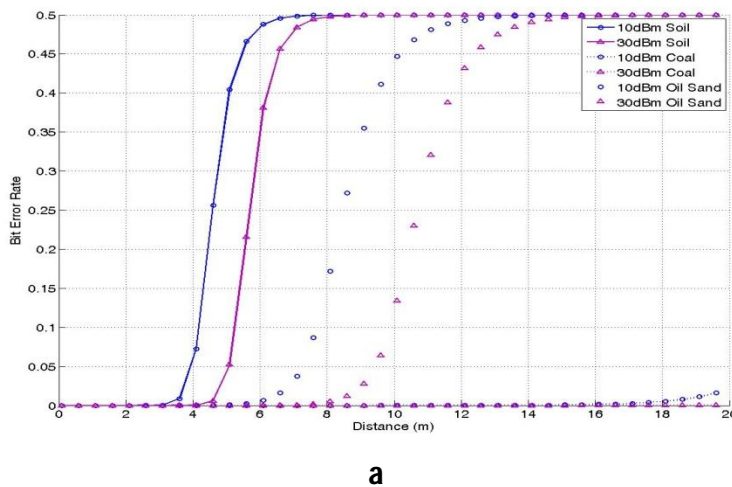

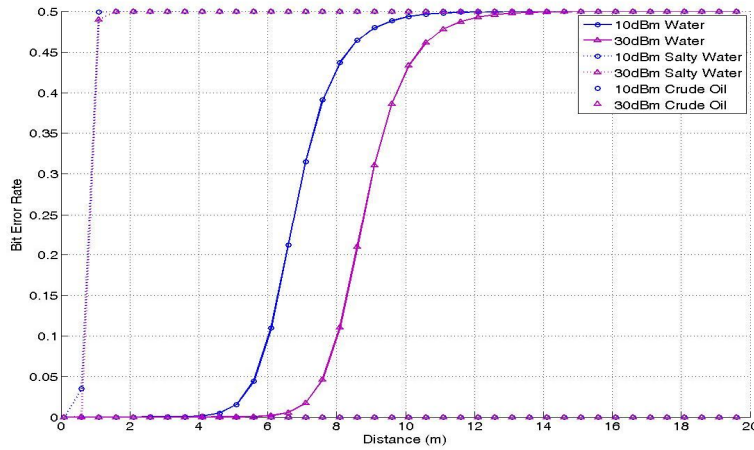

b

Fig. 4 gives the values of BER as a function of the distance for transmission power 10 – 30 dBm at frequency 315 MHz. It can be seen that, when the transmission power increases the communication distance is increases. It can be seen that while for a system operating at 10 dBm the communication range is around 4 m, it is substantially increased to 6 m if the transmission power is 30 dBm in water. Also this increment changes in different ratios at other mediums according to transmission power. Fig. 4 also tell us using the right frequency increases the distance more than changing the transmission power of the sensor.

3. Calculation of Channel Performance

The BER of a communication system depends mainly on three factors: The channel model, the SNR, the modulation technique used by the system. Considering the channel model, the SNR is given by:

$$SNR = P_t - L_f - P_n \begin{cases} P_t = \text{Transmit Power}(10-30\text{dBm}) \\ L_f = \text{Total Path Loss} \\ P_n = \text{Energy of Noise}(-100\text{ dBm}). \end{cases} \quad (8)$$

Here assumed that P_t is between 10 and 30 dBm for our evaluations and P_n is -100 dBm. Although the noise, P_n , may change depending on the properties of the medium, this value is a representative value that can be used to represent the properties of medium BER. The BER also depends on the modulation method. In order to provide an initial investigation in this area, various modulation methods are investigated as well as their effects on BER. From the paper [2, 15-17], it can be seen that the BPSK modulation method provides the largest range in soil. Consequently, in the case of different medium the BPSK modulation is also considered. For the special case BPSK, the BER has a closed form solution which can be expressed as a function of the SNR as: $BER = 0.5\text{erfc}(\sqrt{SNR})$, where $\text{erfc}(\cdot)$ is the error function and SNR is the signal to noise ratio.

The reflection from the surface and the bottom depends on the reflection coefficient at the interface between medium 1 and medium 2. The reflection coefficient is given by Equation 13: [17].

$$\Gamma = \frac{\rho_2 v_2 - \rho_1 v_1}{\rho_2 v_2 + \rho_1 v_1} \quad (9)$$

where ρ_1 and ρ_2 are the density of the first and second medium respectively and v_1 and v_2 are the wave velocity in both mediums. The reflection loss from the surface and from the bottom is PL_{ref} and shown in Equation 10.

$$PL_{ref}(dB) = PL(d) - 10\log V \tag{10}$$

where $PL(d)$ is the path loss due to the single path given in (6) and $10\log V$ is the attenuation factor due to the second path in dB. V is given as follows:

$$V^2(d) = 1 + (\Gamma \cdot \exp(-\alpha\Delta r))^2 - 2\Gamma \exp(-\alpha\Delta r) \times \cos(\pi - (\phi - \frac{2\pi f}{\lambda} \Delta(2))) \tag{11}$$

where, Γ and ϕ are the amplitude and phase angle of the reflection coefficient at the reflection point; $\Delta(r) = r_1 - r_2$ ($r = r_1 + r_2$ in Fig.5) is the difference of the two paths and α is the attenuation constant. Here $d = d_1 + d_2$ is the shortest distance between two sensors, H_i is the shortest distance between the sensor and the interface and r_i is the distance between the sensor and the respecting reflection point. Fig.5 provides a graphical 2D side view representation of the channel path. The single-path channel comprises d_1 and d_2 (path d), while the three-path channel model comprises r_1 and r_2 (reflection from the Medium 2 – Medium 1 interface) and r_3 and r_4 (reflection from the Medium 3 – Medium 1 interface).

Fig.5 Three-path channel model

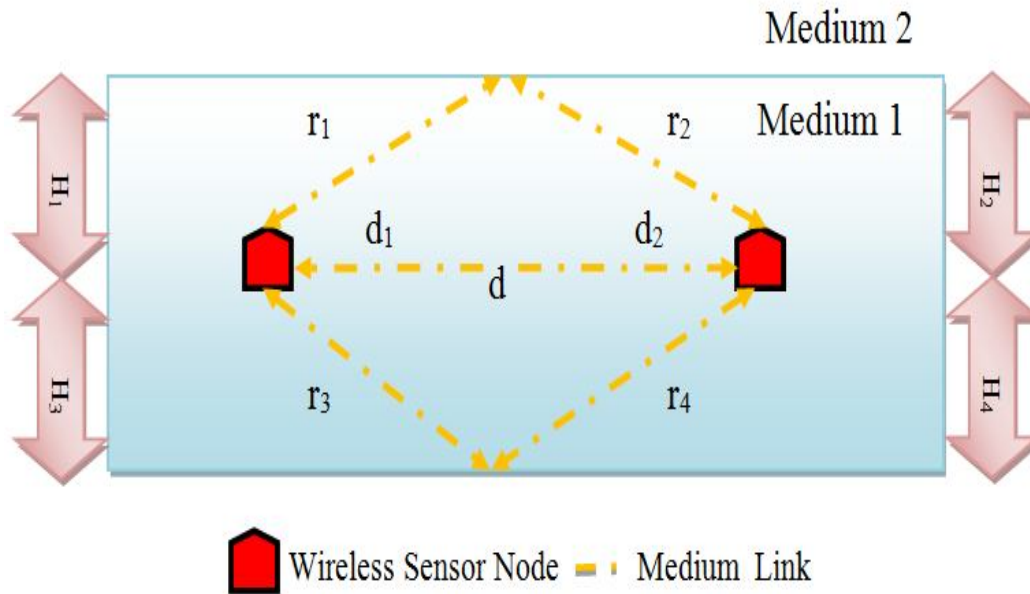

In medium near the surface called shallow medium the reflection coefficients at the medium 1 interfaces with medium 2 and medium 3 have an important contribution in the path loss and thus their effect, which causes the path loss values to fluctuate, cannot be neglected. In this paper medium 1 is calculated as the environment medium which is soil, coal, oil sand, water, salty water and crude oil and medium 2 is calculated as an air.

Fig. 6. Path loss for shallow environment for 315/43 MHz a) for solids b) for liquids

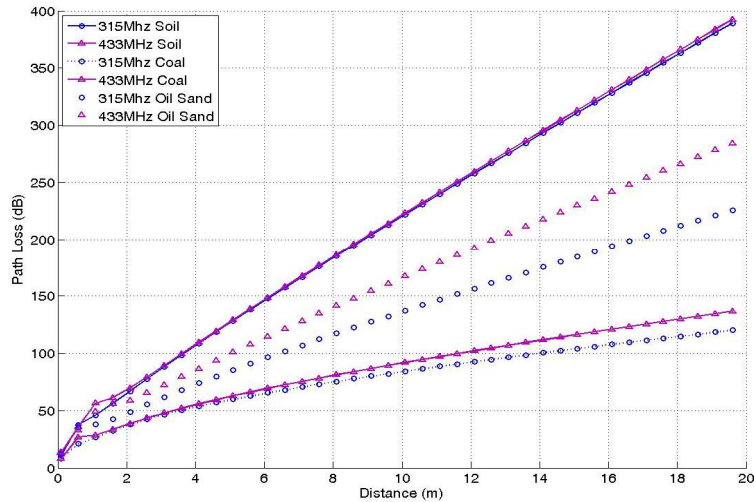

a

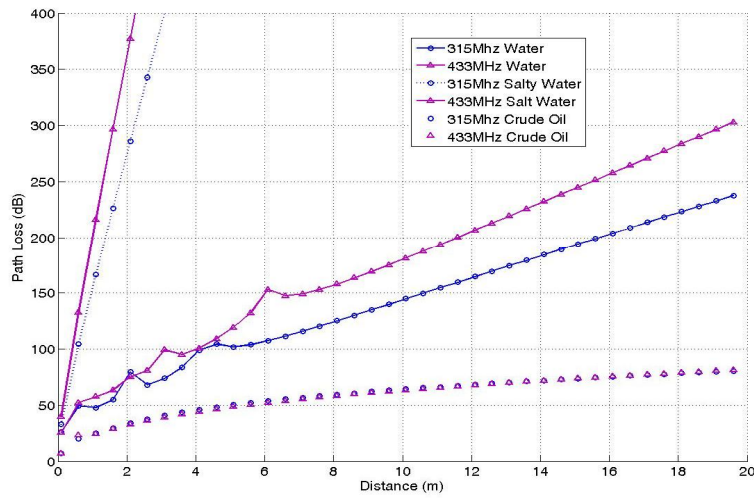

b

The results in Fig. 6 and Fig. 7 clearly show how with the increase in distance and depth these fluctuations in the path loss values become even more ostensible. Fluctuations are caused from the reflection from the medium 2 which have shown in Fig. 5.

Shallow environment and short distance between the sensors increases the reflection. Increasing in the reflection causes increasing the fluctuations. If the results in Fig. 6 are compared with those in Fig. 2 it can be concluded that the path loss of shallow medium is nearly same with the deep medium case. The short distance between the sensors, the predominant component of the received signal is the direct path component while the indirect ones have no significant contribution.

Fig. 7. Path loss for shallow environment as a function of depth for 315/43 MHz a) for solids b)for liquids

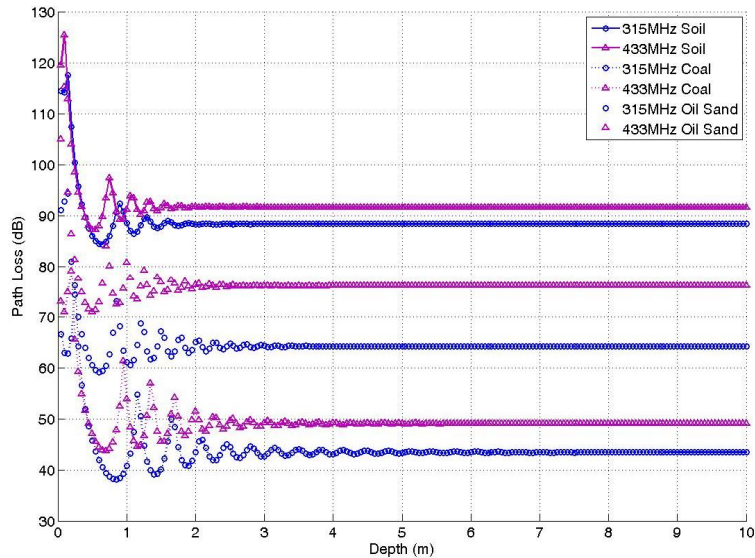

a

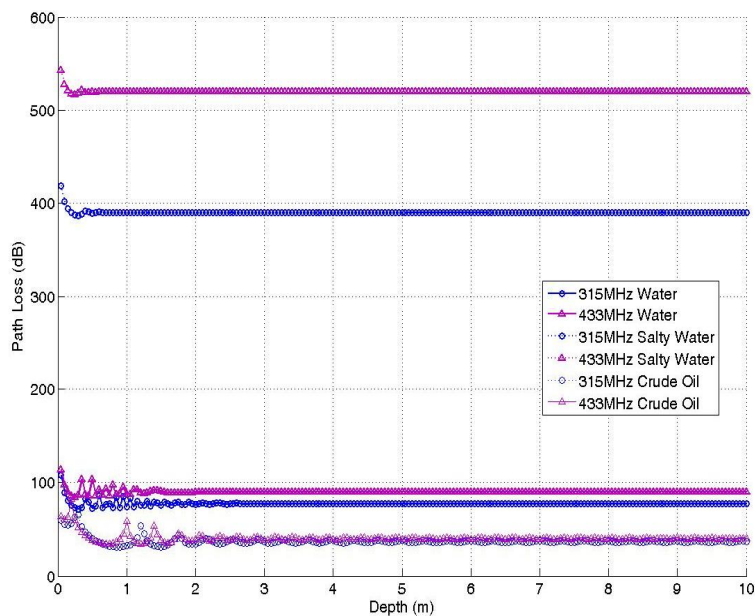

b

In Fig. 7 one can track the change of path loss values as a function of the medium depth. As intuitively expected the fluctuation is reduced with increasing the medium depth and nearly disappears after 2 m soil, 3 m in oil sand and 5 m in coal and in liquids disappears after 0.5 m salty water, 1 m in water and 2 m in crude oil. Thus the conclusion can be made that after a depth of 2 m soil, 3 m in oil sand and 5 m in coal and in liquids 0.5 m salty water, 1 m in water and 2 m in crude oil in modeling the path as “deep medium” single-path model is justified. Also, the fact that the function is more linear after the a few meters depth, justifies the idea that the path loss in deep medium can be suitably modeled by a single-path.

Fig.8. BER for shallow environment as a function of depth for 315/43 MHz a) for solids b)for liquids

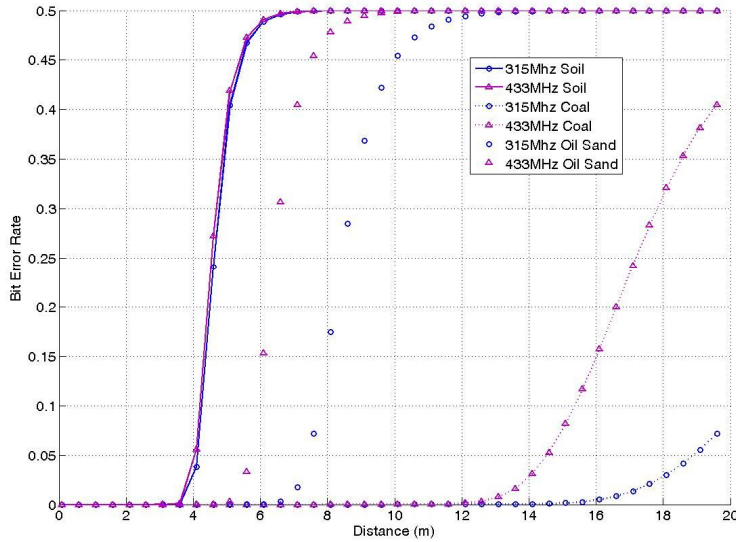

a

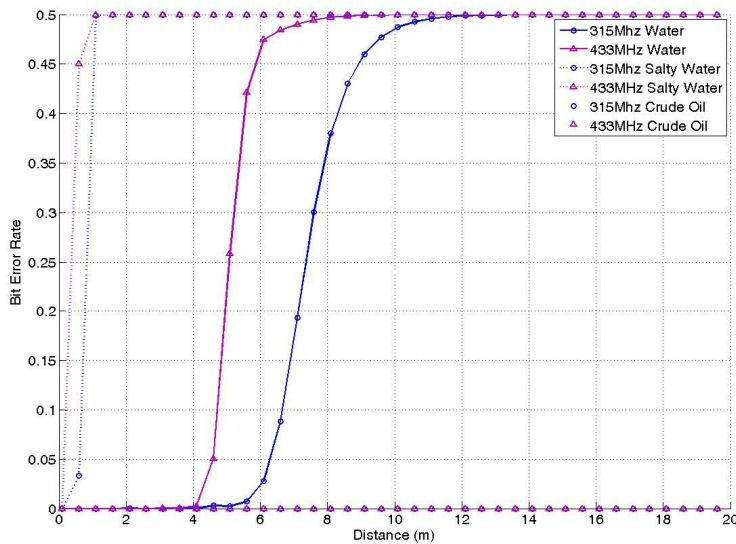

b

For the two-path model, the received signal is the sum of two independent Rayleigh fading signals, which is denoted as location dependent two path Rayleigh channel. Consequently, the composite attenuation constant, X , in multi path Rayleigh channel is [2, 5]:

$$\begin{aligned}
 X^2 = & X_1^2 + \left(X_2 \cdot \Gamma \cdot \exp(-\alpha\Delta(r)) \right)^2 \\
 & - 2 \cdot X_1 \cdot X_2 \cdot \Gamma \cdot \exp(-\alpha\Delta(r)) \\
 & \times \cos \left(\pi - \left(\phi - \frac{2\pi}{\lambda} \Delta(r) \right) \right)
 \end{aligned}
 \tag{12}$$

where X_1 and X_2 are two independent Rayleigh distributed random variables of two paths, respectively. The other parameters are the same with formula 11. In Fig. 8 one can clearly see the effect that the very few increment in distance on the BER. The BER rate increases with the increase in distance. This figure shows that the BER rate for shallow environment nearly same with BER rate for deep environment. The BER rate effected more in small distance.

Fig. 9 BER for shallow environment as a function of depth the transmission power P_t 10 – 30 dBm for 315/43 MHz a) for solids b) for liquids

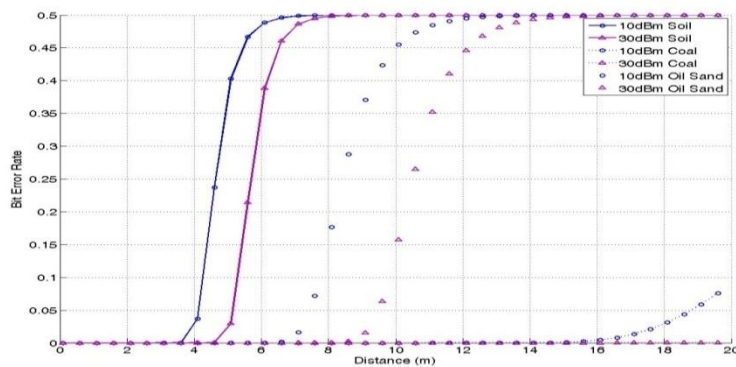

a

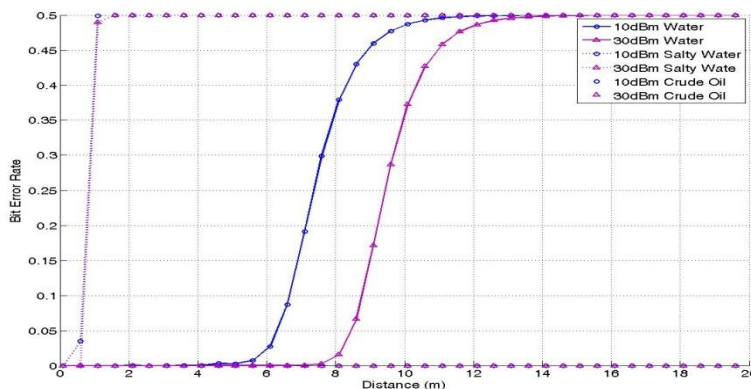

b

Fig.9 shows the BER for shallow environment for the case of transmission power P_t in the range 10-30 dBm, and P_n equal to -100 dBm. As the transmission power is increased the BER is reduced. The increase in transmission power from 10 to 30 dBm results in an increase of the distance of about 0.5 m soil, 1 m in oil sand and 6 m in coal and in liquids distance of about 0.25 m salty water, 2 m in water and 4 m in crude oil. This figure shows that the BER rate for shallow environment nearly same with BER rate for deep environment.

Fig. 8 and Fig. 9 shows that the BER rate effected more in small distance. Also, from Fig. 8 and Fig. 9 tell us path loss in deep medium can be suitably modeled by a single-path in distance more than a few meters.

4. Conclusion

As mentioned before the hostile underground and underwater environments prevents the direct use of most, if not all, existing wireless communication and networking solutions, due to the extremely high path loss, small communication range, and high dynamics of EM waves when penetrating the different medium in the underground and underwater environment. This study aims at providing a detailed theoretical investigation and analytical model for wireless sensor networks used in the case of different media. This paper compared the channel characteristics of the EM waves in solid medium: soil in paper [2], coal in paper [3], oil sand in paper [4] and in liquid medium: water in paper [5], salty water in paper [5] and crude oil in paper [4] which are investigated specifically in the 315/433 MHz band. 315/433 MHz band has been analyzed because of wireless nodes with the RF Transceiver TR1000 and CC1000 like MICA, MICA2, MICA2DOT, Cricket, MANTIS nymph motes can operate in the 315/433 MHz which can increase the efficient communication between sensor nodes comparing with 2.45 GHz. For this reason 315/433 MHz have been used in the analyses.

The results show that the 315/433 MHz band has a weak dependence on both the molecular composition of the medium and the transmission distance in different medium. Thus, the 315/433 MHz band has been analyzed for its suitability for small size sensor developments. Analyzing the medium at 315/433 MHz band can help users in comparisons of propagation characteristics in underwater and underground environments and facilitate deployment. This paper also tell us path loss in deep medium can be suitably modeled by a single-path in distance more than a few meters. In this respect the work, which investigates in detail the specifics of the propagation channel, presents a guideline for other researches that will be working in the promising new field of 315/433 MHz Wireless Sensor Networks.

5. References

- Yick, J., Mukherjee, B., & Ghosal, D. (2008). Wireless sensor network survey. *Computer networks*, 52(12), 2292-2330.
- Vuran, M. C., & Akyildiz, I. F. (2010). Channel model and analysis for wireless underground sensor networks in soil medium. *Physical Communication*, 3(4), 245-254.
- Akkaş, M. A., (2015). Using Wireless Sensor Networks for Mine and Miner Safety. *Wireless Networks*, (ISSN: 1022-0038),1-10.
- Akkaş, M. A., (2015). Channel Modeling of Wireless Sensor Networks in Oil. *Wireless Personal Communications* (ISSN: 0929-6212), Under Review
- Akkaş, M. A., & Sokullu, R. Channel Modeling and Analysis for Wireless Underground Sensor Networks in Water Medium Using Electromagnetic Waves in the 300–700 MHz Range. *Wireless Personal Communications*, 1-20.
- Stuntebeck, E. P., Pompili, D., & Melodia, T. (2006, September). Wireless underground sensor networks using commodity terrestrial motes. In *2nd IEEE Workshop on Wireless Mesh Networks* (Vol. 3, No. 7, pp. 112-114).
- Elrashidi, A., Elleithy, A., Albogame, M., & Elleithy, K. (2012, March). Underwater wireless sensor network communication using electromagnetic waves at resonance frequency 2.4 GHz. In *Proceedings of the 15th Communications and Networking Simulation Symposium* (p. 13). Society for Computer Simulation International.
- Stüber, G. L. (2011). *Principles of mobile communication*. Springer Science & Business Media.
- Komarov, V., Wang, S., & Tang, J. (2005). Permittivity and measurements. *Encyclopedia of RF and microwave engineering*.
- Venkatesh, M. S., & Raghavan, G. S. V. (2004). An overview of microwave processing and dielectric properties of agri-food materials. *Biosystems Engineering*, 88(1), 1-18.
- Gadani, D. H., Rana, V. A., Bhatnagar, S. P., Prajapati, A. N., & Vyas, A. D. (2012). Effect of salinity on the dielectric properties of water. *Indian Journal of Pure and Applied Physics*, 50(6), 405-410.
- Porch, A., Slocombe, D., Beutler, J., Edwards, P., Aldawsari, A., Xiao, T., ... & Almqati, N. (2012). Microwave treatment in oil refining. *Applied Petrochemical Research*, 2(1-2), 37-44.
- Sarri, A., Batisti, M., & Bientinesi, M. (2012, March). Measurements of complex permittivity of geological materials mixtures at RF frequencies. In *Antennas and Propagation (EUCAP), 2012 6th European Conference on* (pp. 2109-2113). IEEE.
- Marland, S., Merchant, A., & Rowson, N. (2001). Dielectric properties of coal. *Fuel*, 80(13), 1839-1849.
- Li, L., Vuran, M. C., & Akyildiz, I. F. (2007, June). Characteristics of underground channel for wireless underground sensor networks. In *6th annual Mediterranean Ad Hoc Networking Workshop*.
- Akyildiz, I. F., Sun, Z., & Vuran, M. C. (2009). Signal propagation techniques for wireless underground communication networks. *Physical Communication*, 2(3), 167-183.
- Vuran, M. C., & Silva, A. R. (2009). Communication Through Soil in Wireless Underground Sensor Networks—Theory and Practice. In *Sensor Networks* (pp. 309-347). Springer Berlin Heidelberg